

## FX816 NMT System Audio Processor

Publication D/816/3 July 1994  
Provisional Issue

### Features/Applications

- Full-Duplex Audio Processing for NMT Cellular System
- On-Chip Speech and SAT Facilities – Tx/Rx/SAT Filtering & Gain – VOGAD – Pre-/De-Emphasis – Deviation Limiter –
- Serial  $\mu$ Processor Interface
- Separate SAT Channel
- “Sidetone” Output Available
- HandsFree Compatibility
- Access to External Processes – Compression – Expansion – Signalling/Data Mixing – VSR Codec (Store/Play) –
- Powersave (Low-Current) Settings

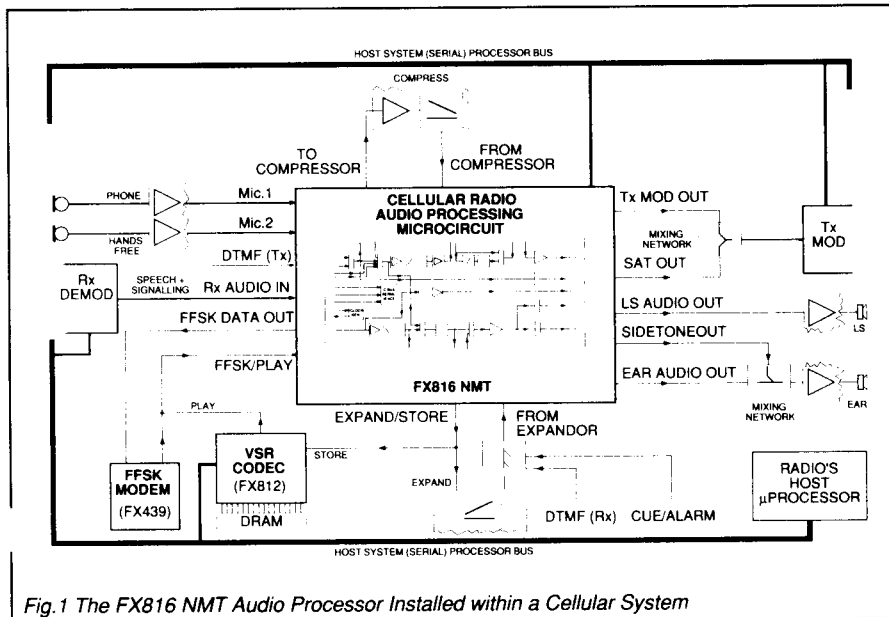

# FX816

Fig.1 The FX816 NMT Audio Processor Installed within a Cellular System

### Brief Description

The FX816 is a  $\mu$ Processor controlled full-duplex audio processor on a single-chip with separate Tx and Rx paths to provide all the filter/gain/limiting functions necessary to pre-process audio, data and signalling in the Nordic Mobile Telephone (NMT) cellular communications system.

Selectable inputs available to the transmit path are: a choice of two microphones, DTMF/signalling or FFSK/data, with access, in this path, to external compression circuitry. Operationally the Tx path provides input gain/filtering, VOGAD, a deviation limiter and Tx Modulation Drive controls.

In the Rx path the SAT signal is separated from the incoming audio via a gain/filter block and made available at a separate pin for mixing externally with the Tx Modulation Drive.

The Rx path consists of an input gain/filter block for voice and data, inputs from an external audio expansion system and an output gain control driving either a loudspeaker system or earpiece.

Unique to the FX816/826/836 cellular audio processors is the ability to route audio (Tx or Rx) to an external Voice Store and Retrieve (VSR) device such as the FX802 or FX812 thus providing the radio system with a voice answering and announcement facility using external DRAM.

The FX816, a low-power CMOS device, which reduces the amount of microcircuits and components required in a cellular audio system by providing more functions on a single chip, is available in 28-pin plastic small outline (S.O.I.C.) surface mount and cerdip DIL packages.

## Pin Number Function

FX816DW	FX816J	
1	1	<b>Xtal:</b> The output of the on-chip clock oscillator.
2	2	<b>Xtal/Clock:</b> The input to the on-chip clock oscillator. A Xtal or externally derived clock ( $f_{XTAL}$ ) should be connected here. Note that operation of the FX816 without a suitable Xtal or clock input may cause device damage. See Figure 2 (notes).
3	3	<b>Serial Clock:</b> The "C-BUS" serial data clock input. This clock, produced by the $\mu$ Controller, is used for transfer timing of commands and data to the FX816. See Timing Diagrams.
4	4	<b>Command Data:</b> The "C-BUS" serial data input from the $\mu$ Controller. Data is loaded to the FX816 in 8-bit bytes, MSB (B7) first, and LSB (B0) last, synchronized to the Serial Clock. See Timing Diagrams.
5	5	<b>Chip Select (CS):</b> The "C-BUS" data loading control function. This input is provided by the $\mu$ Controller. Data transfer sequences are initiated, completed or aborted by the CS signal. See Timing Diagrams.
6	6	<b>V<sub>BIAS</sub>:</b> The internal circuitry bias line, held at $V_{DD}/2$ this pin must be decoupled to $V_{SS}$ . See Figure 2.
7	7	<b>Rx Audio In:</b> Normally taken from the radio's discriminator output, this input has a $1M\Omega$ internal resistor to $V_{BIAS}$ and requires to be connected via a capacitor.
8	8	<b>Expand/Store:</b> A common output that can be used as either an input to an external audio expander or the input to a voice storage medium such as the FX812. Components relevant to the external device requirements should be used at this output. See Figures 2 and 3.
9	9	<b>(Expanded) Audio In:</b> The audio input, via SW5, from an external expander or audio mixing function. This input has a $1M\Omega$ internal resistor to $V_{BIAS}$ and requires to be connected via a capacitor. See Figures 2 and 3.
10	10	<b>Tx Mod Out:</b> The composite Tx audio output to the transmitter modulator from a variable attenuation stage ( $11_{\mu}$ ). This output is set to $V_{BIAS}$ via an internal $1M\Omega$ resistor when set to Powersave or OFF.
11	11	<b>LS Audio Out:</b> An audio output of the Rx path (or selected audios, see Figures 3 and 4) for a loudspeaker system. This is available for handsfree operation. This output can be connected to $V_{BIAS}$ when not required, by SW6 (Configuration Command ( $10_{\mu}$ )). A driver amplifier may be required.
12	12	<b>Ear Audio Out:</b> An audio output of the Rx path (or selected audios, see Figures 3 and 4), available as an output for a handset earpiece. This output in parallel with the LS Audio Out function, can be connected to $V_{BIAS}$ when not required, by SW7 (Configuration Command ( $10_{\mu}$ )). A driver amplifier may be required.
13	13	<b>Sidetone:</b> A switched "sidetone" from the microphone inputs made available for mixing externally with the "Ear" audio. See Figure 3.
14	14	<b>V<sub>SS</sub>:</b> Negative supply rail. Signal ground.

**Notes on Inputs:** To minimize aliasing effects, lowpass filtering may be required at the inputs to this device (especially those supplied from switched-capacitor-type devices) to ensure the input spectrum is kept below 63kHz.

## Pin Number Function

FX816DW FX816J		
15	15	<b>VOGAD:</b> External components (R and C) at this pin control the attack and decay time constants of the on-chip VOGAD function.
16	16	<b>SAT Out:</b> The output of the SAT bandpass filter. This level, which is recovered from the input Rx audio. This tone level can be modified by the SAT and Powersave Command (13 <sub>μ</sub> ) and is available for mixing externally with the transmitter modulation. See Figures 3 and 4.
17	17	<b>Tx Mix In:</b> An input and output available, with external components, to introduce signalling tones into the Tx Path prior to the final level adjustment.
18	18	<b>Tx Filter Out:</b>
19	19	<b>FFSK Out:</b> The de-emphasized Rx audio output available for access to the received FFSK data. This output could be directed to an FFSK Modem such as the FX439.
20	20	<b>Deviation Limiter In:</b> Input to the on-chip deviation limiter. This input should be a.c. coupled to the Pre-Emphasis Out pin. The a.c. coupling will achieve the best possible symmetry of limiting as this input has a 1MΩ internal resistor to V <sub>BIAS</sub> . See Figure 2.
21	21	<b>Pre-Emphasis Out:</b> Audio output from the VOGAD circuitry in the Tx Input Gain/Pre-Emphasis function. This output should be a.c. coupled to the Deviation Limiter In pin. See Figure 2.
22	22	<b>DTMF In:</b> To introduce DTMF type audio, at a suitable level for transmission, to the Tx Path, controlled by SW2 (Configuration Command (10 <sub>μ</sub> )). This input has an internal 1MΩ resistor to V <sub>BIAS</sub> and should be connected via a capacitor.
23	23	<b>Compression In:</b> The audio input from an external compression system. This input has an internal 1MΩ resistor to V <sub>BIAS</sub> and should be connected via a capacitor.
24	24	<b>Compression:</b> The output to an external audio compression system. Currently available compressor/expanders have Op-Amps incorporated. The compressor can be by-passed by SW2.
25	25	<b>Mic.2 In:</b> Tx voice (Mic.) inputs, selectable by SW1 available for handsfree mic./handset mic. or any Tx audio input. Pre-amplification may be required at these inputs. These inputs
26	26	<b>Mic.1 In:</b> each have an internal 1MΩ resistor to V <sub>BIAS</sub> and should be connected via a capacitor.
27	27	<b>FFSK/Play In:</b> The Tx FFSK data input via SW2. This can also be used to input (replay) from a voice storage device such as the FX812. This "replayed" audio can be sent to Rx or Tx paths allowing a Messaging/Voice Notepad/Answering facility. Both FX439 FFSK Modem and FX812 VSR Codec outputs can be wired directly to this pin if the functions are activated one-at-a-time. This input has an internal 1MΩ resistor to V <sub>BIAS</sub> and should be connected via a capacitor.
28	28	<b>V<sub>DD</sub>:</b> Positive supply rail. A single +5-volt power supply is required. Levels and voltages within this Audio Processor are dependent upon this supply.  <i>"C-BUS" is CML's proprietary standard for the transmission of commands and data between a μController and the relevant Cellular microcircuits. It may be used with any μController, and can, if desired, take advantage of the hardware serial I/O functions embodied into many types of μController. The "C-BUS" data rate is determined solely by the μController. For further details refer to CML Publication No. DμINT/1 June 1991.</i>

# Application Information

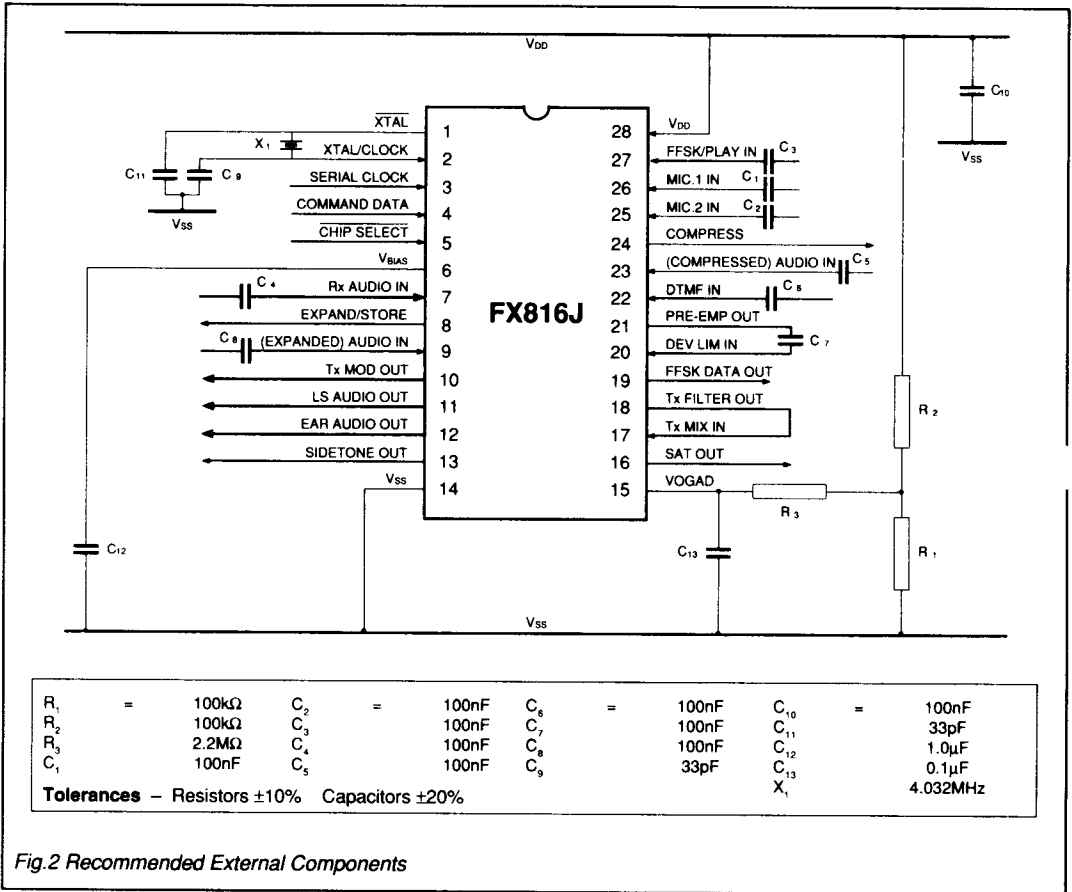

Fig.2 Recommended External Components

## Notes

- Xtal/clock operation**  
 Operation of any CML microcircuit without a Xtal or clock input may cause device damage. To minimise damage in the event of a Xtal/drive failure, it is recommended that the power rail ( $V_{DD}$ ) is fitted with a current limiting device (resistor or fast-reaction fuse).
- VOGAD components**  
 $R_1$ ,  $R_2$ ,  $R_3$  and  $C_{13}$  with the VOGAD Pin internal impedance, form the VOGAD timing circuitry.  
 Control-Voltage Attack Time is set by  $C_{13} \times$  Internal Impedance.  
 Control-Voltage Decay Time is set by  $C_{13} \times R_3$  – assuming  $R_3 \gg R_1$  and  $R_2$ .
- FFSK Modem**  
 The FX469, a general purpose FFSK Modem could be employed with this NMT system Audio Processor. The FX469 is a non-formatted modem, which with due regard to Xtal/clock frequencies and  $\mu$ Processor interface, is compatible with both Mobile/Portable and Base Station applications.
- SAT Output**  
 It is possible, due to the high output impedance of this output, that an external buffer amplifier is required at this output when interfacing or mixing with other system sections.

# NMT Cellular System Interfaces

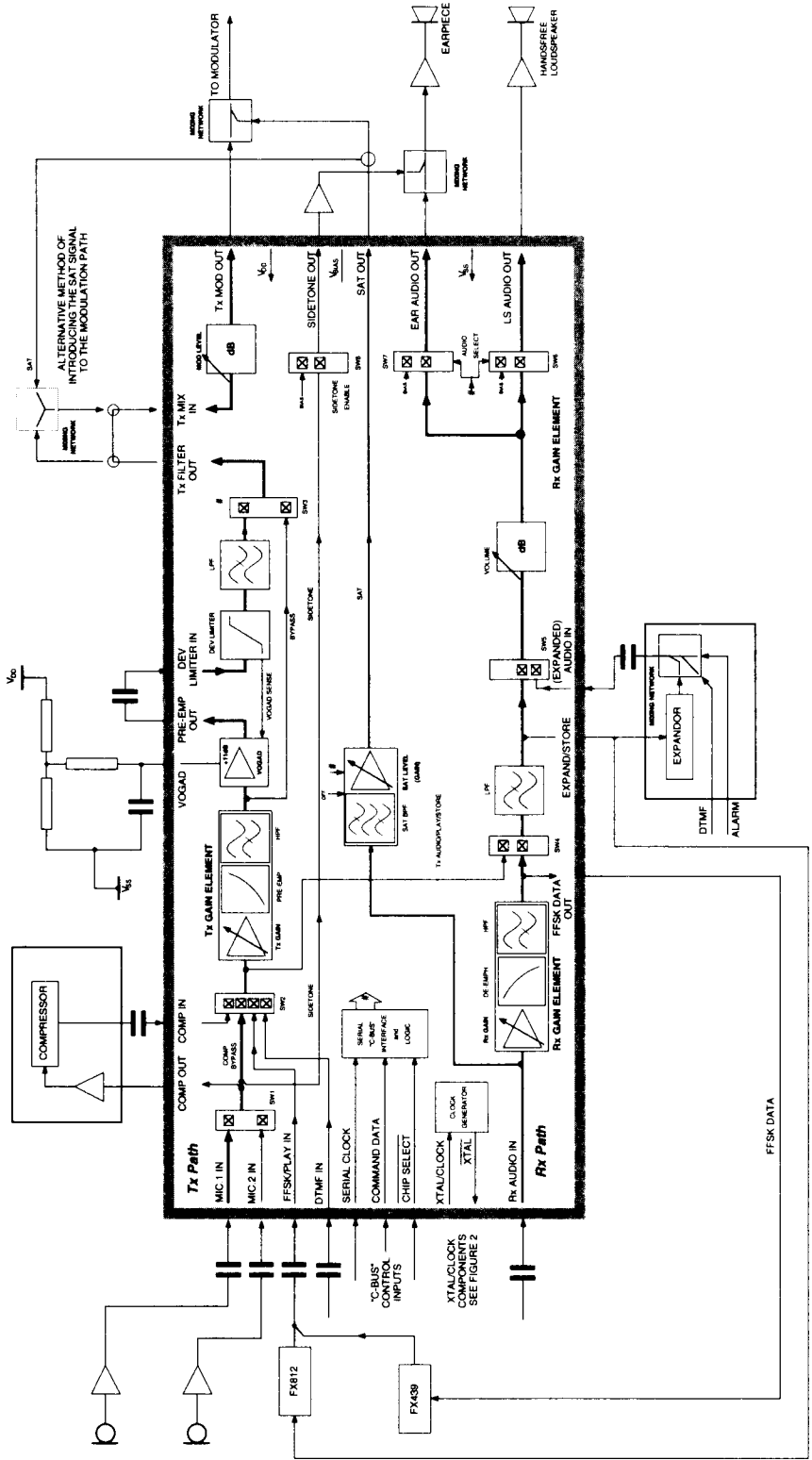

Fig.3 The FX816 within an NMT Cellular Radio System

# The Controlling System

## "C-BUS" Hardware Interface

"C-BUS" is CML's proprietary standard for the transmission of commands and data between a  $\mu$ Controller and CML's New Generation microcircuits.

"C-BUS" has been designed for a low IC pin-count, flexibility in handling variable amounts of data, and simplicity of system design and  $\mu$ Controller software.

It may be used with any  $\mu$ Controller, and can, if desired, take advantage of the hardware serial I/O functions built into many types of  $\mu$ Controller. Because of this flexibility and because the BUS data-rate is determined solely by the  $\mu$ Controller, the system designer has complete freedom to choose a  $\mu$ Controller appropriate to the overall system processing requirements.

Control of the functions and levels within the FX816 NMT Audio Processor is by a group of Address/Commands and appended data instructions from the system  $\mu$ Controller to set/adjust the functions and elements of the device.

The use of these instructions is detailed in the following paragraphs and tables.

Command Assignment	Address/Command (A/C) Byte		Command Data	Table
	Hex	Binary		
		MSB	LSB	
General Reset	01	0 0 0 0 0 0 0 1		
Configuration Command	10	0 0 0 1 0 0 0 0	+	1 byte 2
Tx Gain & Mod. Command	11	0 0 0 1 0 0 0 1	+	1 byte 3
Rx Gain & Vol. Command	12	0 0 0 1 0 0 1 0	+	1 byte 4
SAT & P/Save Command	13	0 0 0 1 0 0 1 1	+	1 byte 5

*Table 1 "C-Bus" Address/Commands*

In "C-BUS" protocol the audio processor is allocated Address/Command (A/C) values 10<sub>H</sub> to 13<sub>H</sub>. Configuration, Tx/Rx Gains and SAT/Powersave assignments and data requirements are given in Table 1. Each instruction consists of an Address/Command (A/C) byte followed by a data instruction formulated from the following tables.

Commands and Data are only to be loaded in the group

configurations detailed, as the "C-BUS" interface recognises the first byte after Chip Select (logic "0") as an Address/Command. Function or Level control data, which is detailed in Tables 2, 3, 4 and 5, is acted upon at the end of the loaded instruction. See Timing Diagrams—Figures 5 and 6.

Upon Power-Up the value of the "bits" in this device will be random (either "0" or "1"). A **General Reset Command (01<sub>H</sub>)** will be required to set all FX816 registers to 00<sub>H</sub>.

### Configuration Command *(Preceded by A/C 10<sub>H</sub>)*

Setting	Control Bits
<b>MSB Bit 7</b>	<b>Transmitted First Sw8 Sidetone</b>
0	Sidetone Bias
1	Sidetone Enabled
<b>6</b>	<b>Sw6/7 Rx Audio</b>
0	Ear Enabled, LS Bias
1	LS Enabled, Ear Bias
<b>5</b>	<b>Sw5 Expander</b>
0	Expander By-Pass
1	Expander Route
<b>4</b>	<b>Sw4 Tx/Rx Audio</b>
0	Tx Store/Audio
1	Rx Store/Audio
<b>3</b>	<b>Sw3 Dev. Limiter</b>
0	Dev. Limiter By-Pass
1	Dev. Limiter Route
<b>2</b>	<b>Sw1 Mic. Inputs</b>
0	Mic. 1 Input
1	Mic.2 Input
<b>1 0</b>	<b>Sw2 Tx Function</b>
0 0	DTMF In
0 1	Compressor In
1 0	Compressor By-Pass
1 1	FFSK/Play In

*Table 2 Configuration Commands*

### Tx Gain & Mod. Command *(Preceded by A/C 11<sub>H</sub>)*

Setting	Gain (dBs)
<b>MSB</b>	<b>Transmitted First Tx Mod. Level</b>
<b>7 6 5 4</b>	OFF (Low Z to V <sub>BIAS</sub> )
0 0 0 0	-5.6
0 0 0 1	-5.2
0 0 1 0	-4.8
0 0 1 1	-4.4
0 1 0 0	-4.0
0 1 0 1	-3.6
0 1 1 0	-3.2
0 1 1 1	-2.8
1 0 0 0	-2.4
1 0 0 1	-2.0
1 0 1 0	-1.6
1 0 1 1	-1.2
1 1 0 0	-0.8
1 1 0 1	-0.4
1 1 1 0	0
<b>3 2 1 0</b>	<b>Tx Input Gain</b>
0 0 0 0	-2.65
0 0 0 1	-2.05
0 0 1 0	-1.50
0 0 1 1	-0.95
0 1 0 0	-0.45
0 1 0 1	0
0 1 1 0	0.45
0 1 1 1	0.85
1 0 0 0	1.25
1 0 0 1	1.65
1 0 1 0	2.05
1 0 1 1	2.40
1 1 0 0	2.70
1 1 0 1	3.05
1 1 1 0	3.35
1 1 1 1	3.65

*Table 3 Tx Gain & Mod. Commands*

# The Controlling System .....

## Rx Gain & Vol. Command *(Preceded by A/C 12,)*

Setting				Gain (dBs)
<b>MSB</b>				<b>Transmitted First Rx LS Volume</b> OFF (Low Z to V <sub>BIAS</sub> )
7	6	5	4	
0	0	0	0	
0	0	0	1	
0	0	1	0	
0	0	1	1	
0	1	0	0	
0	1	0	1	
0	1	1	0	
0	1	1	1	
1	0	0	0	
1	0	0	1	
1	0	1	0	
1	0	1	1	
1	1	0	0	
1	1	0	1	
1	1	1	0	
1	1	1	1	
<b>3</b>				<b>Rx Input Gain</b>
0	0	0	0	
0	0	0	1	
0	0	1	0	
0	0	1	1	
0	1	0	0	
0	1	0	1	
0	1	1	0	
0	1	1	1	
1	0	0	0	
1	0	0	1	
1	0	1	0	
1	0	1	1	
1	1	0	0	
1	1	0	1	
1	1	1	0	
1	1	1	1	

Table 4 Rx Gain and Vol. Commands

## SAT & P/Save Command *(Preceded by A/C 13,)*

Setting				Control Bits
<b>MSB</b>				<b>Transmitted First</b>
<b>Bit 7</b>				
0				Must be a logic "0"
<b>6</b>				Must be a logic "0"
0				
<b>5</b>				<b>SAT Tone Level</b> OFF (Low Z to V <sub>BIAS</sub> )
4	3	2		
0	0	0	0	
0	0	0	1	
0	0	1	0	
0	0	1	1	
0	1	0	0	
0	1	0	1	
0	1	1	0	
0	1	1	1	
1	0	0	0	
1	0	0	1	
1	0	1	0	
1	0	1	1	
1	1	0	0	
1	1	0	1	
1	1	1	0	
1	1	1	1	
<b>1</b>				<b>Powersave Rx Gain Element</b>
0				
1				Powersave Element Enable Element
<b>0</b>				<b>Powersave FX816</b> (except Rx Gain Element) Powersave FX816 Enable FX816
0				
1				
1				

Table 5 SAT and Powersave Commands

## Reference Signal Levels

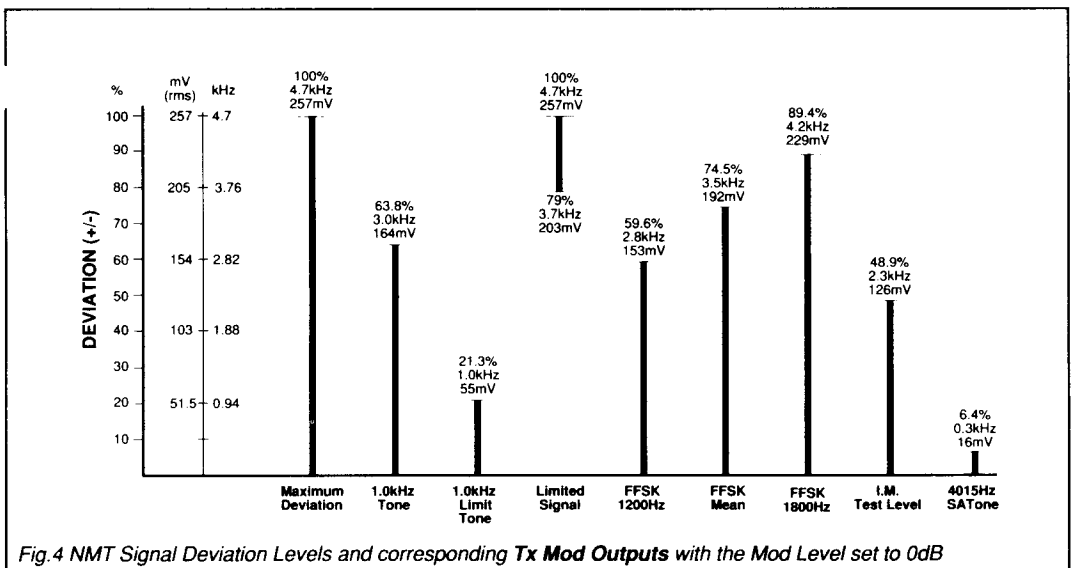

Fig.4 NMT Signal Deviation Levels and corresponding Tx Mod Outputs with the Mod Level set to 0dB

# Control Timing Information

Timing Specification – Figures 5 and 6.

Characteristics	See Note	Min.	Typ.	Max.	Unit
$t_{CSE}$	"CS-Enable to Clock-High"	1	2.0	–	$\mu$ s
$t_{CSH}$	Last "Clock-High to CS-High"	1	4.0	–	$\mu$ s
$t_{CSOFF}$	"CS-High" Time between transactions	1, 2	2.0	–	$\mu$ s
$t_{CK}$	"Clock-Cycle" Time	1	2.0	–	$\mu$ s
$t_{NXT}$	"Inter-Byte" Time	1	4.0	–	$\mu$ s
$t_{CH}$	"Serial Clock-High" Period		500	–	ns
$t_{CL}$	"Serial Clock-Low" Period		500	–	ns
$t_{CDS}$	"Command Data Set-Up" Time		250	–	ns
$t_{CDH}$	"Command Data Hold" Time		0	–	ns

## Notes

1. These Minimum Timing values are altered during operation of the FX812 VSR Codec.
2. Chip Select must be taken to a logic "1" between each individual transaction.

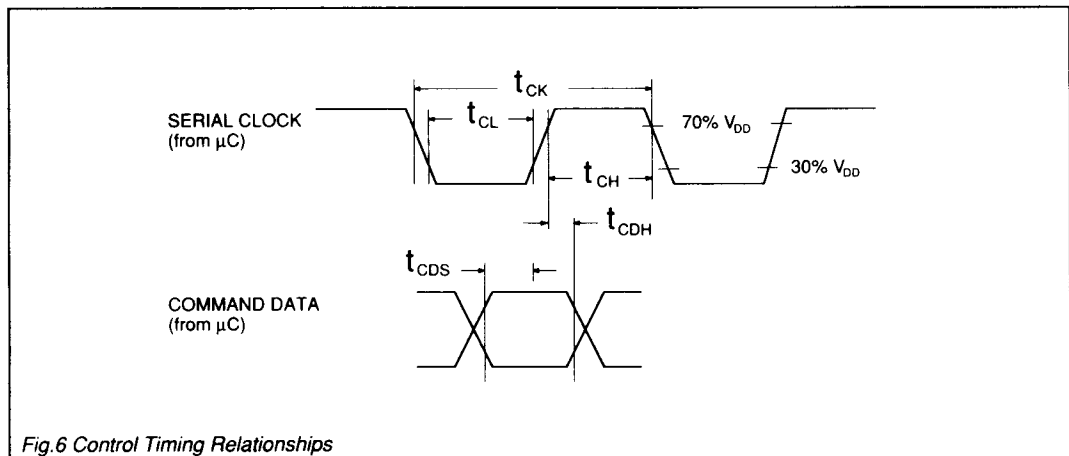
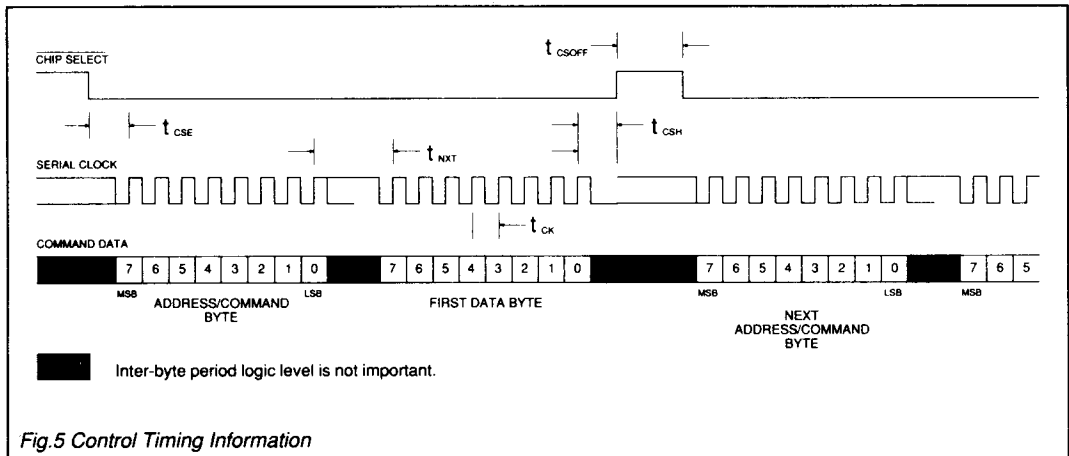



# System Performance

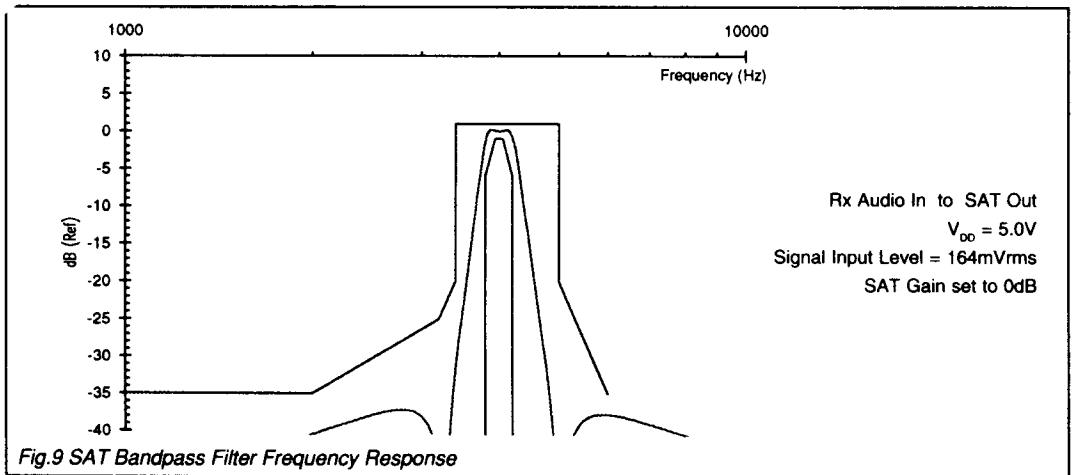
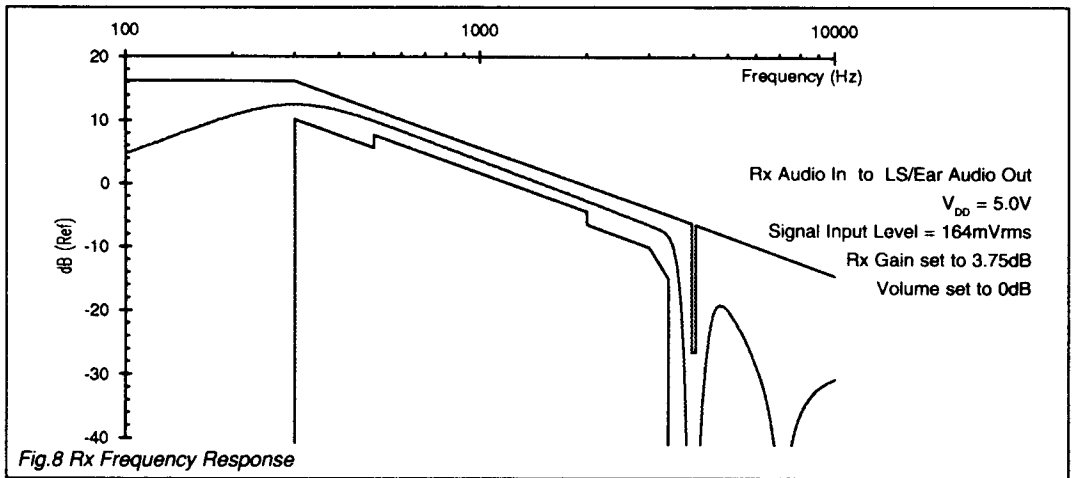
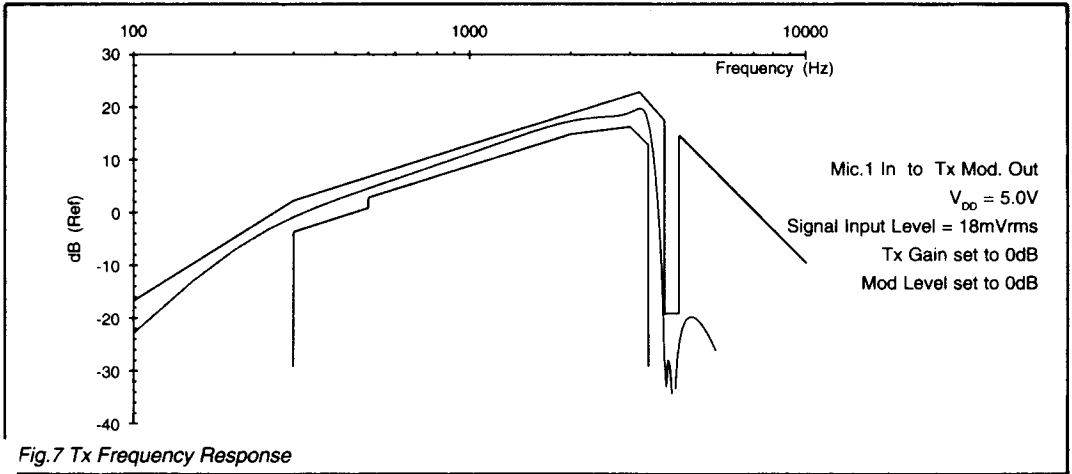

# Specification

## Absolute Maximum Ratings

Exceeding the maximum rating can result in device damage. Operation of the device outside the operating limits is not implied.

Supply voltage		-0.3 to 7.0V
Input voltage at any pin (ref. $V_{SS} = 0V$ )		-0.3 to ( $V_{DD} + 0.3V$ )
Sink/source current (supply pins)		+/- 30mA
(other pins)		+/- 20mA
Total device dissipation @ $T_{AMB} 25^{\circ}C$		800mW Max.
Derating		10mW/ $^{\circ}C$
Operating temperature range:	<b>FX816DW</b>	-40 $^{\circ}C$ to +85 $^{\circ}C$ (plastic)
	<b>FX816J</b>	-40 $^{\circ}C$ to +85 $^{\circ}C$ (cerdip)
Storage temperature range:	<b>FX816DW</b>	-40 $^{\circ}C$ to +85 $^{\circ}C$ (plastic)
	<b>FX816J</b>	-55 $^{\circ}C$ to +125 $^{\circ}C$ (cerdip)

## Operating Limits

All device characteristics are measured under the following conditions unless otherwise specified:

$V_{DD} = 5.0V$ .  $T_{AMB} = 25^{\circ}C$ . Xtal/Clock  $f_0 = 4.032MHz$ . Audio level 0dB ref. = 164mV rms @ 1.0kHz.

Characteristics	See Note	Min.	Typ.	Max.	Unit
<b>Static Values</b>					
Supply Voltage		4.5	5.0	5.5	V
Supply Current					
All Operating		–	6.0	–	mA
Rx Data Mode	1	–	1.0	–	mA
Powersave All		–	0.6	–	mA
Alias Frequency		–	63.0	–	kHz
<b>On-Chip Xtal Oscillator</b>					
$R_{IN}$		10.0	–	–	M $\Omega$
$R_{OUT}$		–	10.0	–	k $\Omega$
Inverter d.c. Voltage Gain		–	10.0	–	V/V
Gain/Bandwidth Product		–	10.0	–	MHz
<b>Analogue Input Impedances</b>					
Mic.1 & 2		–	500	–	k $\Omega$
FFSK/Play		–	500	–	k $\Omega$
Comp In		–	500	–	k $\Omega$
DTMF In		–	500	–	k $\Omega$
Dev. Limiter In		–	100	–	k $\Omega$
(Expanded) Audio In		–	47.0	–	k $\Omega$
Tx Mix In		–	100	–	k $\Omega$
Rx Audio In		–	100	–	k $\Omega$
<b>Analogue Output Impedances</b>					
Pre-Emp Out		–	1.4	–	k $\Omega$
Tx Mod Out		–	600	–	$\Omega$
Expand/Store		–	600	–	$\Omega$
LS and Ear Audio		–	1.0	–	k $\Omega$
FFSK Data Out		–	600	–	$\Omega$
SAT Out		–	10.0	–	k $\Omega$
Tx Filter Out		–	600	–	$\Omega$
VOGAD		–	500	–	$\Omega$
Switches – ON		–	1.0	–	k $\Omega$
– OFF		10.0	–	–	M $\Omega$
<b>Control Interface Parameters</b>					
Input Logic Levels					
Logic "1"	2	3.5	–	–	V
Logic "0"	2	–	–	1.5	V
$I_{IN}$ (logic "1" or "0")	2	-1.0	–	1.0	$\mu A$
Input Capacitance	2	–	–	7.5	pF
<b>Channel Performances</b>					
<b>Tx Path</b>					
<b>Analogue Signal Input Levels</b>					
Mic. 1 and 2	3	–	-11.0	–	dB
FFSK/Play	3	–	-11.0	–	dB
DTMF	3	–	-11.0	–	dB
Comp. In	3	–	-11.0	–	dB
Tx Mix In	3	–	0	–	dB

# Specification .....

Characteristics	See Note	Min.	Typ.	Max.	Unit
<b>Analogue Signal Output Levels</b>					
Pre-Emp Out	3	-	0	-	dB
Tx Filter Out	3	-	0	-	dB
Tx Mod Out	3	-	0	-	dB
Sidetone Out	3	-	-11.0	-	dB
<b>Path Gains/Levels</b>					
<b>Tx Gain – 11<sub>μ</sub></b>					
Nominal Adjustment Range		-2.65	-	3.65	dB
Error of any Setting		-0.2	-	0.2	dB
<b>VOGAD</b>					
Gain (Non-Compressing)		-	11.0	-	dB
(Full Compressing)		-	-34.0	-	dB
Attack Time	4	-	3.0	-	ms
<b>Dev Limiter</b>					
Threshold		-	713	-	mVp-p
Symmetry		-	7.0	-	%
<b>Mod Level Attenuation – 11<sub>μ</sub></b>					
Nominal Adjustment Range		-5.6	-	0	dB
Step Size		0.2	0.4	0.6	dB
Error of any Setting		-1.0	-	1.0	dB
<b>Overall</b>					
Tx Distortion		-	-40.0	-32.0	dBp
Tx Hum and Noise		-	-40.0	-20.0	dB
<b>Rx Signal Path</b>					
Rx Audio Input Level	3	-	-7.0	-	dB
LS/Ear Audio Output Level	3	-	0	-	dB
<b>Path Gains/Levels</b>					
<b>Rx Gain – 12<sub>μ</sub></b>					
Nominal Adjustment Range		3.75	-	9.70	dB
Error of any Setting		-0.2	-	0.2	dB
<b>FFSK Output</b>					
Frequency Range		900	-	2100	Hz
Gain at 1kHz		-1.0	0	1.0	dB
Response		-	6.0	-	db/oct
<b>Volume – 12<sub>μ</sub></b>					
Nominal Adjustment Range		-28.0	-	0	dB
Step Size		1.5	2.0	2.5	dB
Error of any Setting		-1.0	-	1.0	dB
<b>Overall</b>					
Rx Distortion		-	-40.0	-32.0	dBp
Rx Hum and Noise		-	-40.0	-34.0	dB
<b>SAT Signal Path</b>					
<b>Bandpass Filter</b>					
Frequency Range		3945	-	4055	Hz
Gain		-0.5	-	1.5	dB
<b>SAT Level – 13<sub>μ</sub></b>					
Nominal Adjustment Range		-1.95	-	3.50	dB
Error of any Setting		-0.2	-	0.2	dB

- Notes**
1. With reference to the Powersave Command and Figure 3, all functions with the exception of the Rx Gain Element may be powersaved. This will still allow signalling data through the FX816 to activate the system via the  $\mu$ Processor.
  2. Serial Clock, Command Data and Chip Select inputs.
  3. Levels equivalent to  $\pm 3.0$ kHz deviation with the settings below:
    - Tx Gain = 0dB*                      *Mod Level = 0dB*
    - Rx Gain = 7.05dB*                  *Volume = 0dB*
    - SAT Level = 0dB*

Other levels can be achieved by adjusting the above variable gain blocks in accordance with Tables 1 to 5.

4. Using the components shown in Figure 2.

## Package Outlines

The FX816 is available in the package styles outlined below. Mechanical package diagrams and specifications are detailed in Section 10 of this document.

Pin 1 identification marking is shown on the relevant diagram and pins on all package styles number anti-clockwise when viewed from the top.

## Handling Precautions

The FX816 is a CMOS LSI circuit which includes input protection. However precautions should be taken to prevent static discharges which may cause damage.

**FX816DW** 28-pin plastic S.O.I.C. (D1)

**FX816J** 28-pin cerdip DIL (J5)

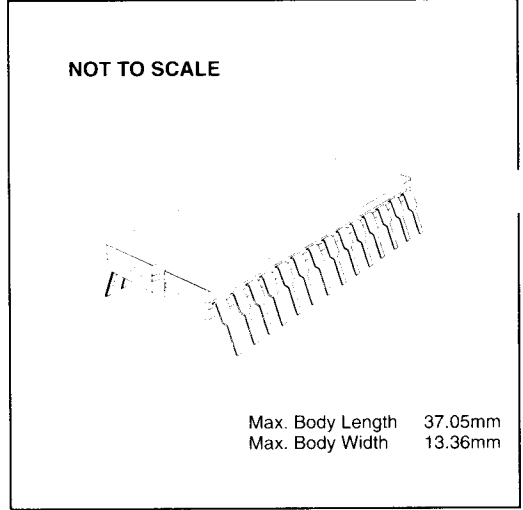
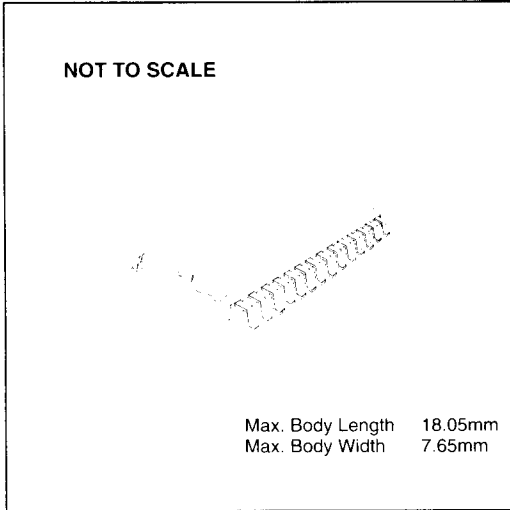

## Ordering Information

**FX816DW** 28-pin plastic S.O.I.C. (D1)

**FX816J** 28-pin cerdip DIL (J5)

CML does not assume any responsibility for the use of any circuitry described. No circuit patent licences are implied and CML reserves the right at any time without notice to change the said circuitry.